



THE FOUNDATION OF LUXURY

From the inception of Redwood, luxury has been a priority. We pride ourselves in offering industry leading features and technology that bring luxury to the forefront. Redwood holds the distinction of being the only RV company started from the ground up by THOR Industries. The product of highly-experienced minds in the RV industry, Redwood has quickly become a flagship for luxury fifth wheels.

We at Redwood believe that greatness is in the details. From the FIT 2.0 Chassis designed specifically to encompass the foundation of luxury, to the iN-Command smart automation system that gives users complete control from the palm of their hand, Redwood is bringing these details to you. Redwood has and will continue to rely on owners and fellow RVers to help shape and define Redwood from generation to generation. Many of the exclusive features Redwood has offered from the beginning were formed by direct input from full-timers and can be found nowhere else. Our continuous commitment to research, development, and customer feedback is what defines our past, present, and future.

Thank you for considering The Foundation of Luxury.





RW-3401RL Interior



RW-3901WB Wine Bar



RW-3901WB Double Sink



RW-3961RK Interior



RW-3941FL Front Living



RW-3881ES Bedroom





RW-3901WB Interior



RW-3881ES Office



RW-3881ES Interior

At the Root of Every Redwo

WELDED HITCH RECEIVER



FIT's integrated hitch receiver can haul 3,000 pounds of additional cargo.

FALCON BRAND AXLES

- Falcon 8,000 lb. axles are built to last and offer many advantages over the competition:
- Upgraded 3 3/8" brakes improve stopping time up to 50% and lower maintenance costs.
 - Powder-coated axle tubes protect against corrosion.
 - EZ-Lube hubs allow for quick and easy maintenance.
 - 6 year warranty



16 PLY 17.5 H RATED TIRES WITH ALUMINUM WHEELS

8 Lug Bearcat aluminum wheels provide the high-end look and ride that each Redwood deserves.

UPGRADED LRE 4100 SUSPENSION SYSTEM WITH WET BOLT



MORryde has designed the LRE system to complement the steel leaf spring suspension. The rubber shear springs isolate and absorb road shock as well as provide 4" of suspension travel. 25% more suspension dampening.

STEP ABOVE ENTRY STEP

The Step Above features the most solid aluminum step available. It also provides a more secure entry and exit of the coach and is designed to rest on the ground when fully extended, providing a solid, safe RV step system.

*All of these features are standard on your Redwood RV

A CUSTOM FIT™ FOR YOU

Falcon Integrated Technology (FIT™ 2.0) ensures quality down to the smallest of details. All components of the FIT™ chassis system are sourced from industry leading manufacturers, producing one of the industry's most sought-after foundations.



ood is a FIT™ 2.0 Foundation

DROP FRAME

- Allows for larger compartment doors
- More overall storage availability

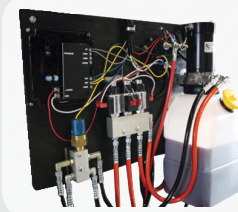

HYDRAULIC SLIDE-OUT SYSTEM

The gold standard for hydraulic slide-out systems, Falcon provides years of worry-free operation and makes us distinct among the competition.

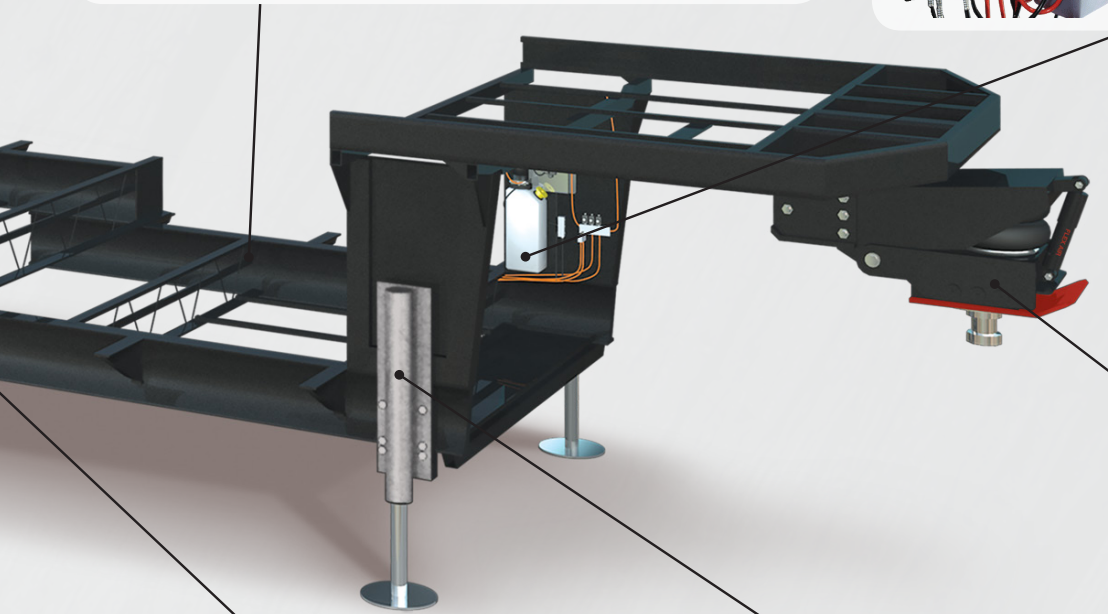

THE FALCON FRAME

The Falcon Frame utilizes the very best materials available and represents the best the industry has to offer:

- Powder coated frame for protection
- Heavy-duty 12" I-Beam main rails
- 10" I-Beam drop frame for increased storage capacity.



6-PT. HYDRAULIC AUTO LEVEL

Gone are the days of boards, blocks, and backaches. Every Redwood comes standard with a fully-automatic 6-pt. hydraulic Level Up system, accented with LED's. With the touch of a button (and in less than a minute), you can be leveled and ready to relax. When you're ready to go again, a memory function returns the pin box to the height of your truck's hitch.



FLEX AIR PIN BOX

The Flex Air® Pin Box provides the smoothest towing quality in the industry. The integrated air bag, rubber compound and the oil filled shock absorber reduce chucking and the vertical tug-of-war between your 5th wheel and truck. Superior 5th wheels make the Flex Air pin box standard.



Additionally, having a custom chassis system from industry leaders allows for the use of many industry firsts. This keeps the features and technology of the FIT™ chassis at the forefront of the best the RV industry has to offer.

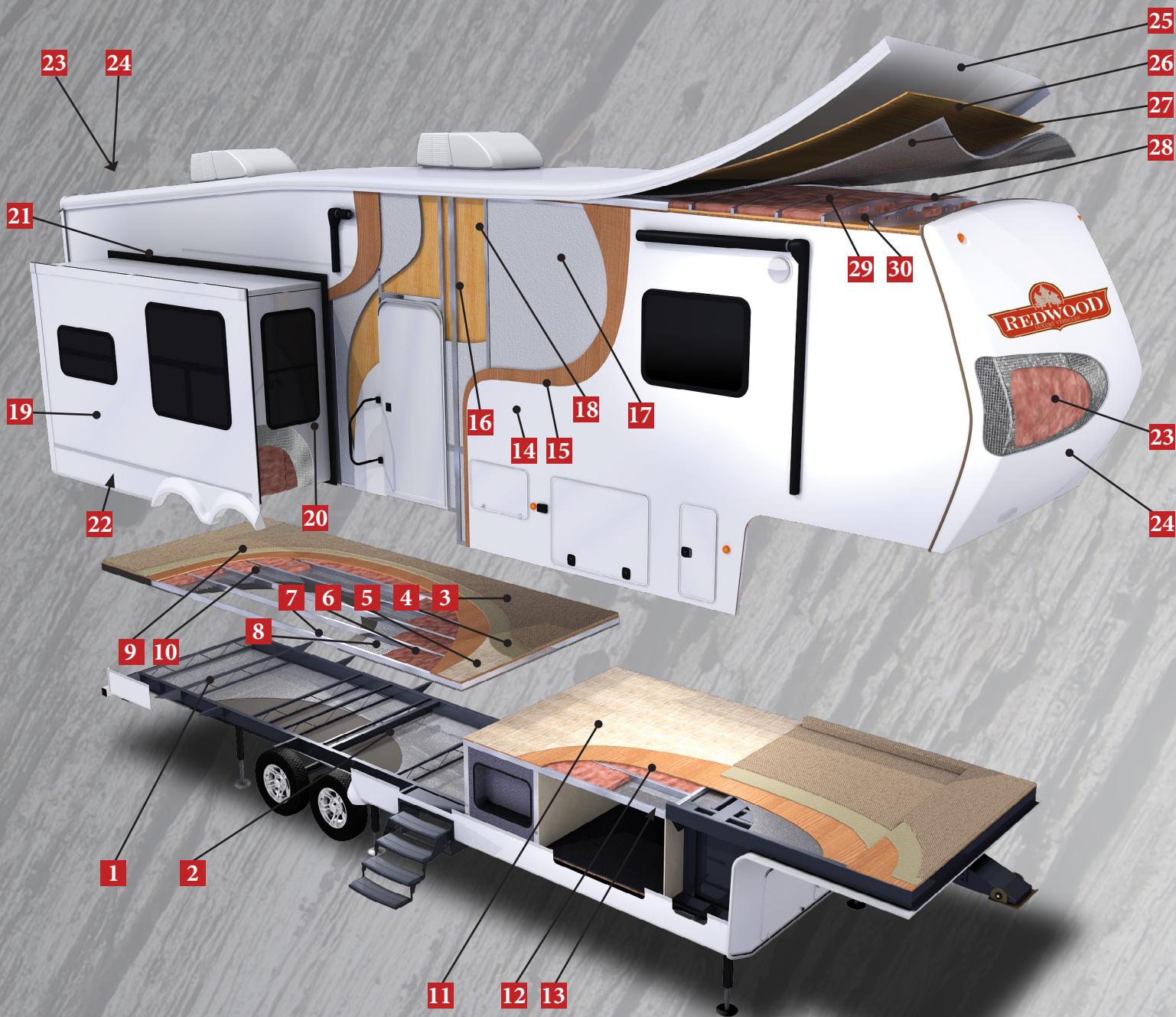

SUBFLOOR

- 1. F.I.T. Frame
- 2. Corrugated Underbelly

FLOOR

- 3. Shaw Residential Carpet
- 4. Residential Carpet Pad
- 5. Congoleum Vinyl Flooring
- 6. 5/8" Floor Decking
- 7. 3" Welded Aluminum Frame
- 8. Radiant Techno Foil Insulation
- 9. 2 Layers Batten Insulation
- 10. Darco Moisture Barrier

BATH DECK

- 11. 5/8" Floor Decking

- 12. 3" Welded Aluminum Frame

- 13. Finished Pass-Thru Ceiling

SIDEWALLS

- 14. High-Gloss Fiberglass
- 15. Double Luan Backer
- 16. 2" Welded Aluminum Frame
- 17. Sanded Block Foam Insulation
- 18. Interior Wall Board

SLIDE OUTS

- 19. **Laminated Outside Wall**
- 20. **Slide End Walls**
 - Fiberglass Layer
 - Batten Insulation
- 21. **Slide Roof**
 - Alpha Ply Roofing

- Batten Insulation

- 22. **Slide Floor**

- Darco Moisture Barrier

FRONT/REAR CAPS

- 23. 1 Layers Batten Insulation
- 24. Molded Fiberglass Cap

ROOF

- 25. Alpha Ply Roofing
- 26. 3/8" Roof Decking
- 27. Radiant Techno Foil Insulation
- 28. Stamped Steel Roof Trusses
- 29. 1 Layers Batten Insulation
- 30. Interior Ceiling Board

Relax. You're iN-Command[®]

**Display
Commander**



**Redwood
Standard**

**CONTROL YOUR
REDWOOD RV
FROM ANY
SMART PHONE
OR TABLET***

**PROVEN
AUTOMOTIVE-GRADE
TECHNOLOGY**

- ✓ **Never lose your controller**
- ✓ **Unlimited Users**
- ✓ **When you have your phone,
you're iN-Command**

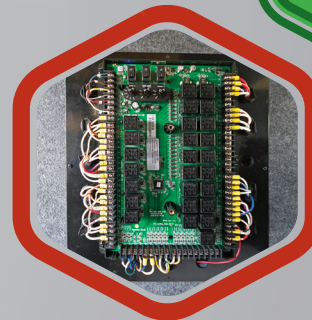

**Download and Install
the Free JENSEN
iN-Command™ App
from Google Play or
Apple App Store for the
ultimate in control.**



*WORKS WITH iPhone, iPad,
ANDROID PHONES AND TABLETS.

Control • Systems Monitoring • Safety



The latest advancement, iN-Command Global Connect™ allows you to control select function of your RV using your smart device from anywhere in the world.

FINALLY A SYSTEM YOU CAN TRUST.

iN-Command embraces the next generation of controls for your Redwood RV by acting as the central hub of operations and puts you at the helm using your preferred smart device. But how does this all-encompassing system work? What, exactly, does it monitor and control? Let's take a closer look at iN-Command piece by piece.

Body Control Module

At the core of iN-Command is the control board, or "brain" of the system, the Body Control Module. The main board, itself, is protected by an impact resistant cover. The inside of this cover features detailed connection labeling, along with the wiring guide.

The Display Commander is your primary point of contact with iN-Command. All of the switches and monitoring panels that have cluttered up interior walls in the past are integrated into this one sleek, touch screen monitor. What really makes the Display Commander stand out, however, is that it can be controlled remotely with a smart device using the free JENSEN iN-Command mobile app. This app performs all of the same functions as the Display Commander, but from the convenience of your mobile device.

REAL TEMPERATURE TESTED!

NO NEED FOR R-VALUES



- A/C SYSTEM TESTED IN **110°** ENVIRONMENT*
- FURNACE TESTED IN **0°** ENVIRONMENT*

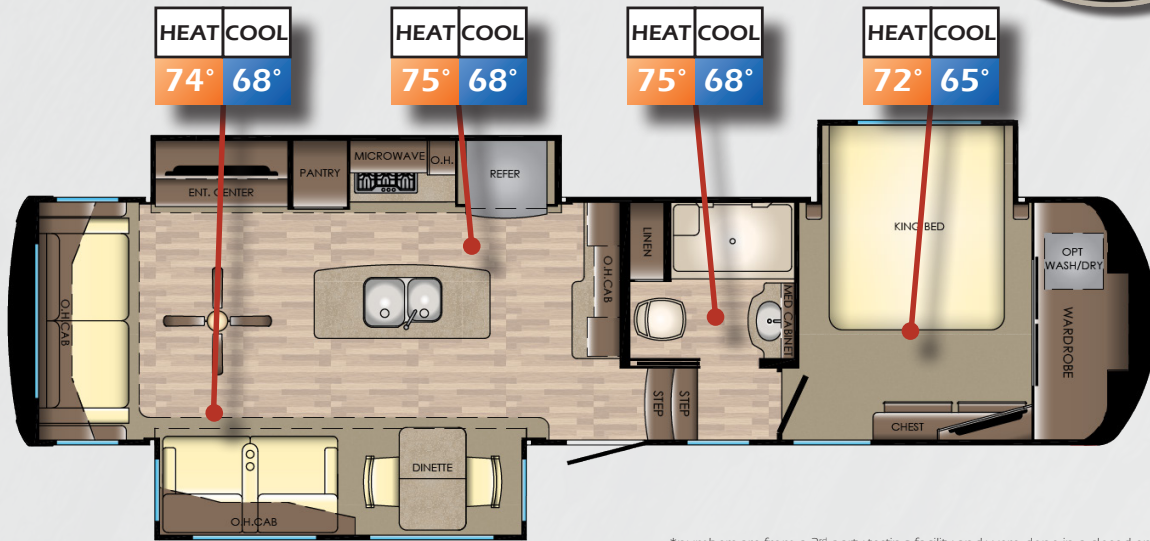

*numbers are from a 3rd party testing facility and were done in a closed environment

REDWOOD DREAM KITCHEN

- Pullout pantry w/ outlet
- Dedicated plate storage drawer
- Cutting board over trash
- True tiled back splash
- Higher than average island
- Stainless residential appliances
- USB and outlets in island
- Dedicated trash bin drawer
- Residential Hidden Hinges
- Full Extension Ball Bearing Guides



PAINT AND COLOR OPTIONS



Autumn Fire



Twilight

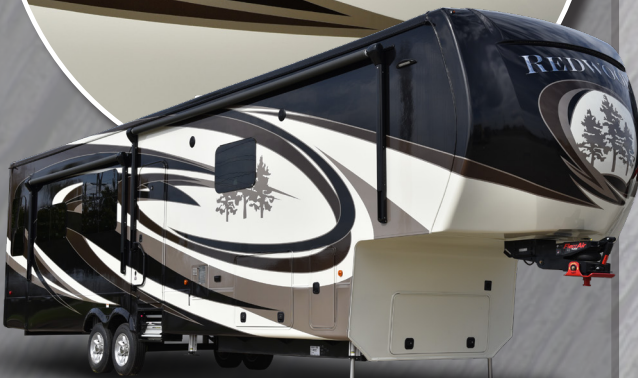

Prairie Vista



Partial Paint

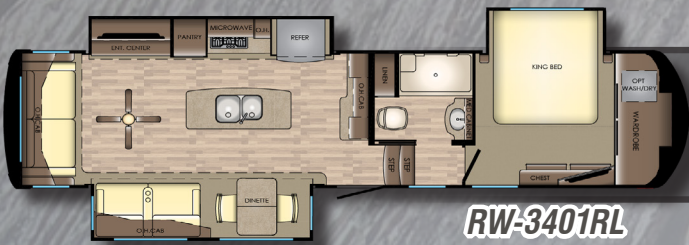

WEIGHT	LENGTH	HEIGHT	FRESH W	BLACK W	GRAY W	HITCH
13482	36' 8"	13' 6"	62 Gal	45 Gal	88 Gal	2362

RW-3401RL

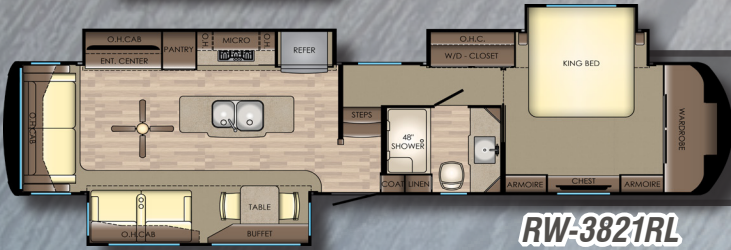

WEIGHT	LENGTH	HEIGHT	FRESH W	BLACK W	GRAY W	HITCH
14498	40' 5"	13' 6"	62 Gal	45 Gal	88 Gal	2580

RW-3821RL



WEIGHT	LENGTH	HEIGHT	FRESH W	BLACK W	GRAY W	HITCH
14432	41' 8"	13' 6"	62 Gal	45 Gal	88 Gal	2580

RW-3881ES

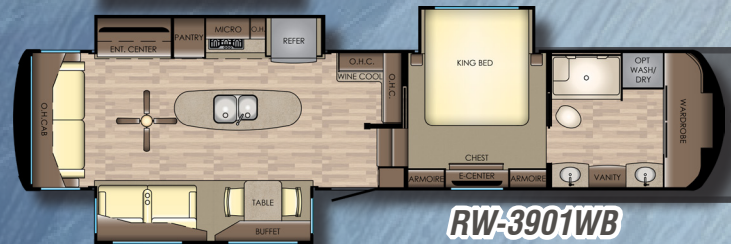

WEIGHT	LENGTH	HEIGHT	FRESH W	BLACK W	GRAY W	HITCH
14312	40' 2"	13' 6"	62 Gal	44 Gal	88 Gal	2412

RW-3901WB



WEIGHT	LENGTH	HEIGHT	FRESH W	BLACK W	GRAY W	HITCH
14402	40' 2"	13' 6"	62 Gal	88 Gal	88 Gal	2570

RW-3901MB

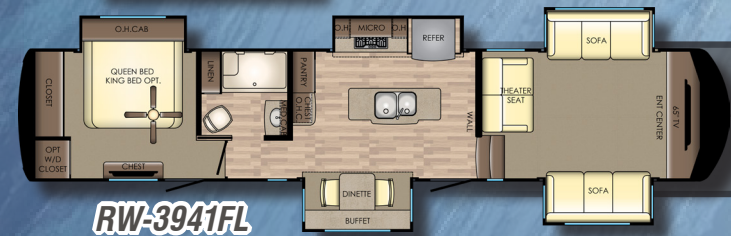

WEIGHT	LENGTH	HEIGHT	FRESH W	BLACK W	GRAY W	HITCH
14458	41' 10"	13' 6"	62 Gal	45 Gal	90 Gal	2982

RW-3941FL



WEIGHT	LENGTH	HEIGHT	FRESH W	BLACK W	GRAY W	HITCH
14274	40' 11"	13' 6"	62 Gal	45 Gal	132 Gal	2608

RW-3961RK



WEIGHT	LENGTH	HEIGHT	FRESH W	BLACK W	GRAY W	HITCH
14682	41' 5"	13' 6"	62 Gal	45 Gal	88 Gal	2620

RW-3991RD

STANDARDS AND OPTIONS

KITCHEN & APPLIANCES

- Solid Cherry Hardwood Cabinetry
- Hardwood Stiles Pre-Drilled & Screwed Together
- Residential Sized Storage Drawers
- Pots & Pans Storage
- Full-Extension Ball-Bearing Drawer Guides
- Residential Soft Close Hidden Hinges
- EGS Steel Backed Cabinet Anchors
- Residential Pantry w/ Pullout Drawers & 110v Outlet
- Solid Surface Countertops
- Matching Solid Surface Sink Covers
- Tile Backsplash
- Oversized 60/40 Stainless Steel Sink
- High Rise Island w/ Pullout Cutting-board & Dedicated Garbage Cabinet
- High Rise Faucet w/Pull Out Sprayer
- Over-Island Lighting
- 22 Ft³ Residential Refrigerator w/ 1K Watt Inverter (In all Residential Models)
- 18 Ft³ Side-by-Side Norcold Refrigerator w/ Ice Maker (In all RV Refrigerator Models)
- Residential 3-Burner Gas Cooktop
- 30" Stainless OTR Microwave w/ Exhaust Fan
- Max Air Fan w/ Rain Censor
- Residential Style Oven

BEDROOM

- iCool™ Gel Foam King Bed
- 110v Outlets on Both Sides of Bed
- USB Ports on Both Sides of Bed
- 39" LED HDTV
- Residential Dresser w/ Drawers
- Walk-In Closet with Shelving (8 ft. wide)
- Night Roller Shades
- 2nd 15k BTU Whisper Quiet A/C w/Heat Pump

LIVING AREA

- Thomas Pane Collection Furniture Package:
 - » Residential Hide-a-Bed Sofa
 - » Tru-Sit 5 Function Recliners Theatre Seating
 - » Buffet –Style Adjustable Dinette w/ Leaf Extension (VBM)
 - » 2 Premium Dinette Chairs
 - » 2 Folding Dinette Chairs
- Day/Night Roller Shades
- 55"-65" HDR HDTV (VBM)
- Bluetooth Entertainment System w/ Soundbar & Powered Subwoofer
- Pre-wired for Winegard® Satellite Systems
- 2 USB Ports Beside Sofa
- Additional USB Ports w/ Buffet Models
- Ceiling Fan (VBM)
- 5,100 BTU Fireplace

BATHROOM

- One Piece Fiberglass Shower
- Domed Skylight in Shower
- Porcelain Foot Flush Toilet
- Heat & A/C Duct in Bathroom

- Max Air Fan w/ Rain Censor
- Adjustable Handheld Shower Head
- Solid Surface Countertops

GENERAL INTERIOR

- Energy Management System (EMS)
- iN-Command™ Smart Automation System
- LED Recessed Ceiling & Accent Lights
- Solid Hardwood Slide Fascia
- 7' Interior Slide Room Height
- 15,000 BTU Whisper Quiet A/C
- 35,000 BTU Furnace
- Residential Carpet w/ Pad
- Maximum Linoleum Throughout
- Central Vacuum w/ Power Dust Pan
- Magnetic Door Stops
- USB Ports Throughout
- Accessory Charging Station
- Custom Coffered Ceiling Treatment
- Washer Dryer Prep

CONSTRUCTION

Chassis

- Custom FIT Chassis
 - » Falcon 12"/10" I-Beam Drop Frame
 - » Flex Air Pin Box
 - » Falcon Hydraulic Slide Out System w/ Manual Override (Main Slides)
 - » Falcon 8,000 lb. Axles
 - » MORryde LRE 4100 Suspension System
 - » 6-Point Hydraulic Jacks w/Auto Leveling
 - » MORryde Lift Assist Steps
 - » Falcon 2" (3,000 lb.) Receiver Hitch
 - » 17.5 H Rated Tires (w/ Spare)

Sidewalls

- 2" Laminated Wall
- Sanded Block Foam Insulation
- Double Welded Aluminum Frame
- Double Luan Backer
- High-Gloss Gel Coat Fiberglass

Floor

- 5/8" Floor Decking
- 3" Aluminum Subfloor – 11" on Center (VBM)
- 2 Layers of Batten Fiberglass Insulation
- 1 Layers of Radiant Tech Foil Insulation
- Darco Moisture Barrier
- Corrugated Underbelly
- Fully Enclosed & Heated Underbelly

Roof

- One Piece Alpha-Ply Roof Material
- 5" Reinforced Trussed Roof Rafter System
- Double Trusses at each A/C
- 3/8" Roof Decking
- 1 Layers of Batten Fiberglass Insulation
- 1 Layer of Radiant Tech Foil Insulation
- Fully Walkable

General Exterior

- Straight Roof Line (Luxury Profile)
- Front & Rear Insulated Fiberglass Caps

- LED Pin Box Light
- Electric Adjustable Awning w/ LED Lights
- 2nd Power Awning w/ LED (VBM)
- Docking Station w/ All Hookups & Black Tank Flush
- Insulated Slam Latch Baggage Doors
- Fully Finished & Heated Pass-Through Storage w/ Netting
- Radio in Pass-Through
- Exterior Speakers w/ LED Lights
- Bauer Keyed-A-Like Lock System
- (2) 45 Gallon Grey Tanks (VBM)
- 45 Gallon Black Tank (VBM)
- Tanks Heated via Forced Heat
- 12 gal. DSI Hot Water Heater
- Enclosed & Heated Water Lines
- Seamless Residential Insulated Heat Ducts
- 2-Zoned Radius House A/C Ducting System
- Frameless Dual Pane Windows
- Solar Prep
- Wireless Backup Camera Prep
- 50 Amp Service
- Progressive 90 Amp/12v DC Power Converter
- Power Cord Reel-Electric (VBM)
- 110v Exterior Receptacle
- Aluminum Wheels
- 3-3/8" Self-Adjusting Drum Brakes
- (2) 30 lb. LP Tanks w/Auto Change Over

Options

- High Efficiency Dishwasher
- 3rd 15,000 BTU A/C
- 5.5 Onan LP Generator
- Holding Tank Heating Pads
- Slide Awning Package
- Disc Brakes
- Full Body Paint
- Generator Prep

- Parks Package
- Full Time Living Package

*VBM - Varies By Model

ALL NEW HIGH GLOSS WOOD FINISH



All new high gloss wood finish comes standard in every Redwood RV. This mirror like finish on our Pacific Cherry cabinets is made possible through a seven step, sanding process. Each piece of cabinetry is built and inspected by hand to eliminate mass machining. The biscuit corners are glued and nailed to give these cabinets ultimate strength and durability. The finished product has the highest sheen rating available to give you a truly residential look.

Decor Options

Wood



Ansley



Kingston



Pacific Cherry



**Ansley
decor in the
RW-3901WB**



**Kingston
decor in the
RW-3881ES**



THE FOUNDATION OF LUXURY, WARRANTIES TOO!

2-YEARS LIMITED BASE WARRANTY

THE REDWOOD LIMITED BASE WARRANTY COVERS YOUR RV FOR A PERIOD OF (2) YEARS FROM THE DATE OF PURCHASE BY THE ORIGINAL OWNER. THIS LIMITED WARRANTY COVERS DEFECTS IN MATERIALS & WORKMANSHIP SUPPLIED BY AND ATTRIBUTED TO CROSSROADS MANUFACTURING & ASSEMBLY OF THE RV.



3-YEARS LIMITED STRUCTURAL WARRANTY

EFFECTIVE FOR REDWOOD RECREATIONAL VEHICLES MANUFACTURED ON OR AFTER SEPTEMBER 1, 2017.

THE LIMITED STRUCTURAL WARRANTY COVERS YOUR RV FOR A PERIOD OF THREE (3) YEARS FROM THE DATE OF PURCHASE BY THE ORIGINAL OWNER. THIS STRUCTURAL WARRANTY COVERS THE WORKMANSHIP ATTRIBUTABLE TO CROSSROADS MANUFACTURING AND ASSEMBLY OF THE STRUCTURAL PORTIONS OF YOUR RV. STRUCTURAL COVERAGE INCLUDES:

- MAIN STEEL FRAME
- STEEL FRAME OUTRIGGERS & CROSS MEMBERS
- SKELETAL FRAMING (WALL STUDS, FLOOR JOISTS, ROOF RAFTERS)
- SIDEWALLS (LAMINATED & NON-LAMINATED)
- ROOF (LAMINATED & NON-LAMINATED)
- ROOF MATERIALS INSTALLATION
- FLOORS (LAMINATED & NON-LAMINATED)
- FRONT & REAR WALLS (LAMINATED & NON-LAMINATED)
- ALL SLIDE OUT BOXES & APPLICABLE STRUCTURAL COMPONENTS
- FIBERGLASS FRONT CAPS (PAINT FADE, CRACKING)
- FRONT CAP WINDSHIELD INSTALLATION
- FULLY TRANSFERABLE



EVEN MORE PROTECTION

SELECT COMPONENTS FROM SUPPLIERS THAT STAND BEHIND THEIR PRODUCTS

LIFETIME	TREDIT-ALUMINUM WHEELS (STEEL 2 YEARS)	
25 YEARS	DYNA SPAN-FLOOR DECKING	WESCO-FLEX PEX PIPING (FITTINGS 10 YEARS, EXCLUSIONS)
12 YEARS	ALPHA SYSTEMS-ROOFING MATERIAL	DICOR-ROOFING MATERIAL
7 YEARS	BEAUFLOOR-VINYL FLOORING	
6 YEARS	LIPPERT-AXLES	INTERVAC-CENTRAL VACUUM (ACCESSORIES 90 DAYS)
	DEXTER-AXLES	HP PRODUCTS-CENTRAL VACUUM
5 YEARS	SAMSUNG-REFRIGERATOR - SEALED SYSTEM AND LABOR ON DIGITAL INVERTER COMPRESSOR (10 YEARS ON COMPRESSOR PARTS)	
	WINEGARD RAZOR Z1-ANTENNA SYSTEM PARTS	WINEGARD ROADSTAR-ANTENNA SYSTEM PARTS
3 YEARS	MOR/RYDE-RUBBER SUSPENSION SYSTEM (IS SYSTEM 5 YEARS, CRE SYSTEM 2 YEARS)	ONAN-GENERATOR ENGINE (ELECTRICAL 2 YEARS)
	TREKK-FLOORING	STANDARD TECHNOLOGIES-FUEL PUMP SYSTEM
	BGS-GRAPHICS (5 YEAR LIMITED)	
2 YEARS	ASA ADVENT-AIR CONDITIONER	ATERRA-CONVERTER
	ATWOOD-STOVE/OVEN	CHENG-CONVERTER
	COLEMAN-AIR CONDITIONER	CRANE-EXTERIOR FIBERGLASS
	DOMETIC-AIR CONDITIONER (PARTS AND FREIGHT 3 YEARS)	DOMETIC-REFRIGERATOR (PARTS AND FREIGHT 3 YEARS)
	FLO JET-WATER PUMP	FANTASTIC FAN-(DOME - LIFETIME)
	WFCO-WATER PUMP	PROGRESSIVE DYNAMICS-CONVERTER
	SUBURBAN-FURNACE (HEAT EXCHANGE 5 YEARS)	ATWOOD-FURNACE
	SUBURBAN-WATER HEATER (TANK 3 YEARS)	SUBURBAN-OVEN
	WINEGARD-ANTENNA SYSTEM PARTS	VENTLINE-POWER FAN

THIS IS ONLY A SUMMARY. FOR COMPLETE INFORMATION REGARDING THE ACTUAL WARRANTY STATEMENT(S) CONSULT THE WRITTEN LIMITED WARRANTY PROVIDED BY EACH SUPPLIER WHICH CAN BE FOUND IN THE COMPONENT SUPPLIER OWNER'S MANUAL INCLUDED WITH YOUR RECREATIONAL VEHICLE OR ON THE SUPPLIER(S) WEBSITE.

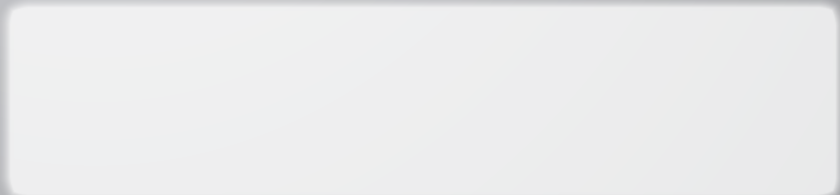

www.redwood-rv.com • 1140 W. Lake St Topeka, IN 46571 • (260) 593 - 3850

DISCLAIMER: Product information is as accurate as possible as of the date of publication of this brochure. All features, floor plans, and specifications in this brochure are subject to change without notice. Please also consult Redwood's web site at www.redwood-rv.com for more current product information and specifications. Tow Vehicle Disclaimer. CAUTION: Owners of Redwood recreational vehicles are solely responsible for the selection and proper use of tow vehicles. All customers should consult with a motor vehicle manufacturer or their dealer concerning the purchase and use of suitable tow vehicles for Redwood products. Redwood RV disclaims any liability or damages suffered as a result of the selection, operation, use or misuse of a tow vehicle. CROSSROADS' LIMITED WARRANTY DOES NOT COVER DAMAGE TO THE RECREATIONAL VEHICLE OR THE TOW VEHICLE AS A RESULT OF THE SELECTION, OPERATION, USE OR MISUSE OF THE TOW VEHICLE. REFERENCE CROSSROADS RV COMPANY OWNERS MANUAL FOR LIMITED WARRANTY DETAILS. *Length is defined as the distance from the centerline of hitch pin/coupler to rear bumper of trailer.

